

# CREATIVE TENT SOLUTIONS

Industrial Pop-Up Tents & Umbrellas for Weather Protection

## POP'N'WORK - GS6611

POP'N'WORK TENTS SET-UP IN SECONDS WITH NO LOOSE PARTS. EXCLUSIVE POP'N'WORK UNIFIED FRAME MADE WITH COLD ROLLED STEEL AND FIBERGLASS IS VIRTUALLY UNBREAKABLE.

### FEATURES

- ◆ ONE DOOR TENT WITH AN 'A' SHAPE ZIPPER DOOR
- ◆ 7-1/2" X 16" VENT WINDOW IN THE BACK
- ◆ 10" BLOWER PORT IN THE BACK
- ◆ 12" GROUND FLAPS ON TWO SIDES
- ◆ 14' WINDLINES ON TWO SIDES
- ◆ QUICK-PACK STORAGE WRAP FOR EASY STORAGE
- ◆ WEIGHT: 34LBS
- ◆ FOLDED DIMENSIONS: 74" x 8" x 8"

\*Customization and additional features available

## SPECIFICATIONS - 6' x 6' FOOTPRINT

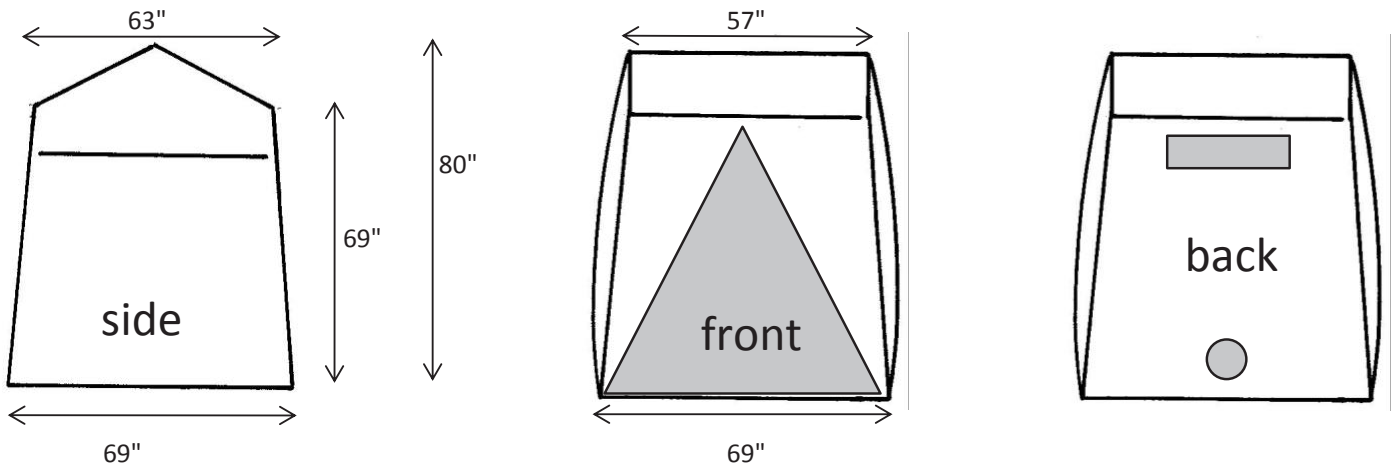

### COVER

- ◆ SAFETY GREEN 300 DENIER COATED POLYESTER SIDEWALLS
- ◆ WHITE 250 DENIER COATED POLYESTER DOORS, BACK, AND ROOF
- ◆ URETHANE COATED POLYESTER
- ◆ FLAME RETARDANT - CPAI 84
- ◆ WATER REPELLENT

### FRAME

- ◆ 18 GAUGE GALVANIZED TUBING FOR ROOF AND GROUND STRUTS
- ◆ COLD ROLLED STEEL HINGES
- ◆ 70% GLASS CONTENT FIBERGLASS ROD TENSION FRAME
- ◆ PITCHED ROOF